



silvadec



Life is composite

Let your desires speak !

DISCOVER OUR
COMPOSITE
DECKING WITH
AN ATTRACTIVE
IPE EXOTIC WOOD
FINISH!

P. 4

OUR
ADVICE ON
MAINTENANCE

P. 34

OUR SOLUTIONS
FOR OUTDOOR
FEATURES

DECKING

P. 07

FENCING

P. 19

CLADDING

P. 30

DECKING • FENCING • CLADDING



Contents

New - Our composite decking with the aesthetic appeal of Ipe exotic wood P. 4

Our decking P. 7

Our fencing P. 19

Our cladding types P. 30

Our advice on maintenance P. 34

Editorial and graphic design:

Ekinox communication

Photo credits:

Yves Berrier, Samuel Bigot, Franck Betermin, AdobeStock

Published in January 2023

The photos and colours depicted in this document are not contractually binding. The information is provided for reference only and may be modified without notice.

Thanks to:

Mailys Bonnet, 727 Sailbags, Keneah Jardin, Le rendez-vous Carnac, Jean-Michel Mesguen and PCA-Stream



**Terms of the warranty can be downloaded from www.silvadec.com*

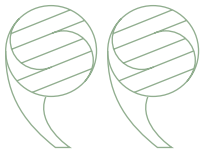

Welcome to the Silvadec universe!

We live in a composite world.

Our planet is complex, mostly composed of water, gas, rock and fire, and with a surface that offers us mountains, deserts, oceans and forests.

As crew members on the same vessel, inhabitants of Earth, mankind and all other species in nature coexist in every imaginable way. Without a doubt, combining human activity with nature's needs is the challenge of the millennium.

Our Silvadec® composite is ready to fulfil its role in this challenge by proposing an innovative material made from wood – natural by nature – combined with a polymer through cutting-edge technological research, and yours to experience. This approach aligns with the circular economy principles that are, and will remain, part of our DNA. The French and German expertise we have developed is now patented.

This means that our deck, fence and cladding boards are the best assets for composing outdoor living spaces where design, traceability, quality and durability all converge.

What drives us? The desire to provide bespoke, environmentally responsible solutions dedicated to people and their homes, opening up the scope of outdoor design possibilities.

Since our beginnings as pioneers in composite, we have become the European leader.



*Time
to bring
composite
into your
life*

NEW DECKING



NEW

You won't be able to resist our Ipe Atmosphere decking !

Our new Ipe Atmosphere deck board covers all the colour shades of the Ipe wood deck boards, offering a sustainable alternative to exotic wood.

The colours of this Silvadec® wood composite board will remain stable over time, with no treatment.

There is no need to apply a saturator; your decking won't fade to grey.



**Terms of the warranty can be downloaded from www.silvadec.com*

THE + POINTS

Attractive finish
of Ipe wood!

Stable colour without
treatment (does not fade to
grey)

Splinter-free

Rot-resistant

Compatible with all the
decking accessories
(see page 16)

USES

- Residential
- Public facilities
- Decking and swimming pool
decks
- Outdoor kitchens,
including in sheltered or
semi-sheltered areas

The sustainable alternative to tropical wood!

Created by combining two materials (wood flour and polymers) using co-extrusion technology, our Atmosphere board offers highly concentrated performance. Its colour remains intense as the seasons pass.

Being rot-resistant, it suits both outdoor and sheltered areas. It is waterproof, and therefore ideal for outdoor dining as clean-up of household stains is easy!

Its slip resistance means that you can relax on your decking with complete peace of mind.



1

Quality:

Our commitment: to offer you a high-quality, sustainable product that is easy to clean, robust and built to last, thanks to its unique formulation made mainly from wood: approximately 2/3 wood flour and 1/3 high-density polyethylene (without additives).

When it comes to defining "rot-resistant", our 25-year-guaranteed boards speak for themselves.



**Terms of the warranty can be downloaded from www.silvadec.com*

2

Design:

At your service is the expertise of our research and development teams; each year they come up with a wide range of products, colours and finishes you can use to personalise your outdoor space.

With top-ranking architects putting their faith in us, our boards now grace the exteriors of international landmarks such as the Hôtel Prince de Galles in Paris, and Barcelona Airport, not forgetting the decking high up on Montparnasse Tower. **You, too, can choose a bold design suited to your taste.**



Silvadec hits the right note! Creating your outdoor space by harmonising four elements

3

Circularity:

Our recyclable composite is made from wood chips and finely ground sawdust sourced from local sawmills, combined with virgin or recycled polymer.

So it should tick all your boxes as regards environmental responsibility.

**Feeling unsure? Why not contact our customer service?
We like to keep everything transparent.**

4

Outdoor space as a lifestyle:

Every day, the women and men behind the scenes at Silvadec strive to bring you the best solutions for outdoor spaces.

Our ranges open the scope of possibilities for your decking, fences and cladding.

Over to you to tailor the space and the life enjoyed in it!

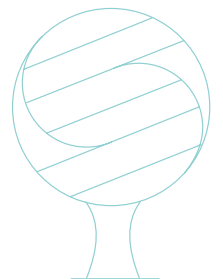

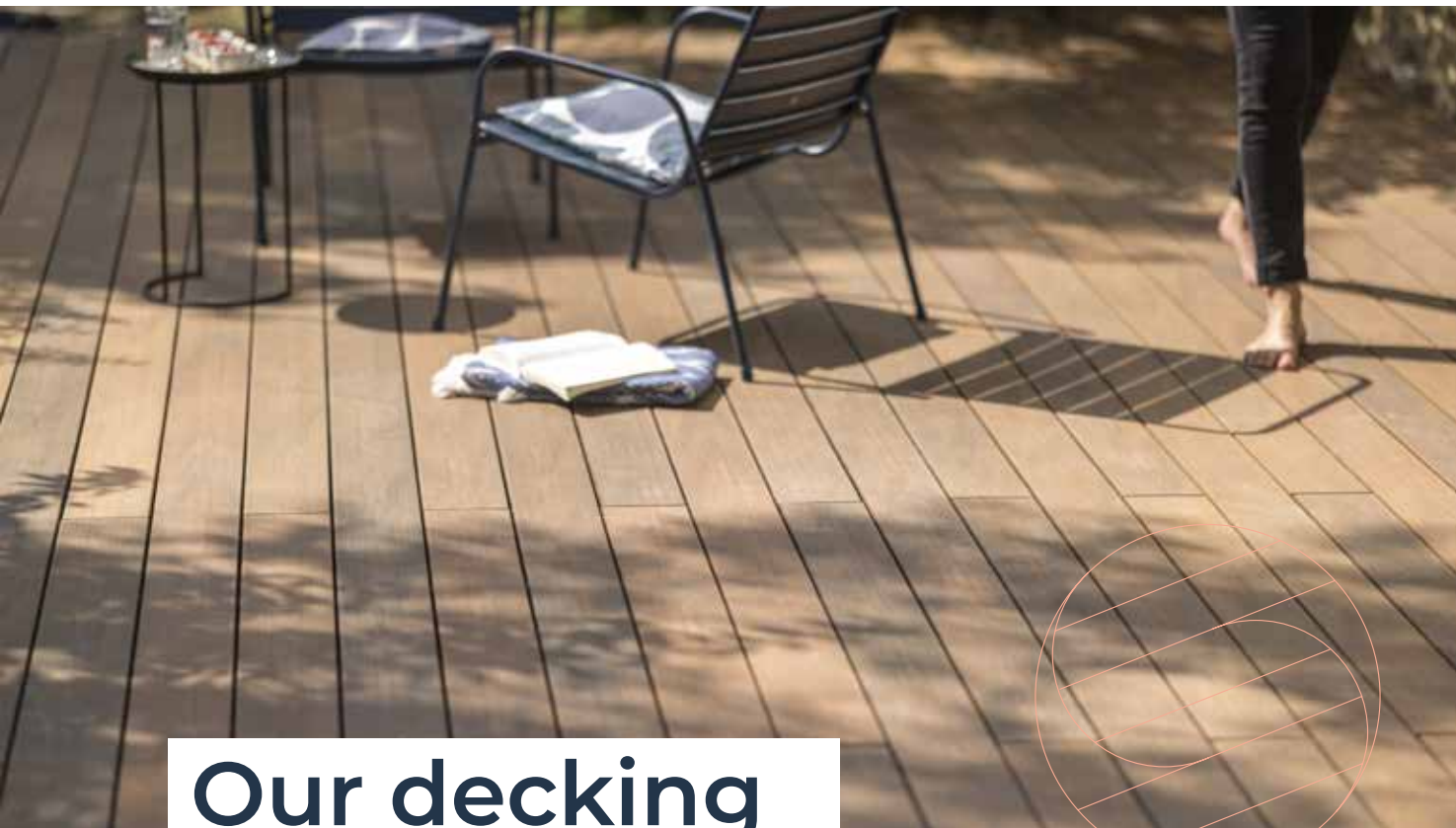

Our decking

The hardest part is deciding!

Choose your decking from our selection of composite deck boards.

Elegance, Emotion and Atmosphere all offer different aesthetic and technical qualities, and are compatible with all our installation and finishing accessories.

Elegance board	P. 8
Emotion board	P. 12
Atmosphere board	P. 14
Create your decking	P. 16



What colour will your board be?

Whatever the colour, the temperature of our boards in the sun is close to that of exotic wood deck boards, except for the Atmosphere board which has a protective polymer coating.

Due to their high proportion of wood, our boards heat up less in the sun than other composites. An advantage of dark colours is that they are less prone to show dirt, while light colours are less hot on bare feet.

“With Elegance boards, set your creativity free!”



→ Anthracite Grey

Get a taste of freedom to design your outdoor space any way you wish, thanks to the range of Elegance board colours and finishes!

The + points

- Splinter-free
- Does not fade to grey like solid wood
- No treatment is required
- Rot-resistant
- UV-resistant
- Frost-resistant
- Guaranteed for 25 years*

* Terms of the warranty can be downloaded from www.silvadec.com

Choose the finish that best suits your project

	Grooved finish	Smooth finish	Embossed finish
SCRATCH RESISTANCE	***	*	**
EASE OF REPAIR OF THE SURFACE APPEARANCE (SIMPLY BY SANDING)	**	***	*
SLIP RESISTANCE	***	**	**
COMFORTABLE BAREFOOT ON SUNLIT SURFACE (T° OF THE BOARD IN THE SUN) COMPARED TO EXOTIC WOOD	**	**	**
EASY CLEAN-UP OF HOUSEHOLD STAINS	**	**	**

USES

- Decking and swimming pool decks
- Public or private areas open to pedestrian use
 - Outside
 (not suitable for covered or semi-covered locations)



A bronzing phenomenon, entirely natural and temporary, will cause the boards to turn yellow when first exposed to UV rays. After a few weeks outdoors exposed to UV and rain, they return to almost their original colour! (see p. 34)

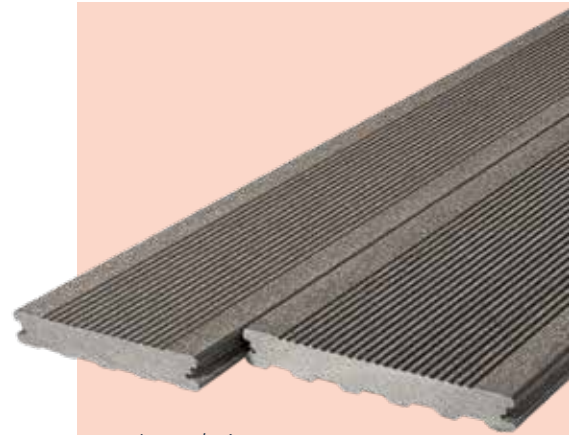
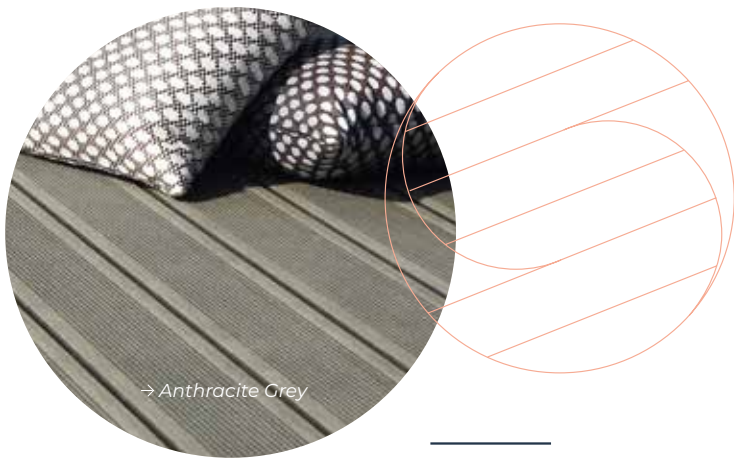

Length 4 m,
width 138 or 180 mm

TIMELESS

Grooved Elegance board

With optimal slip resistance, Elegance is ideal for designing your poolside and relaxation spaces where safety is key.

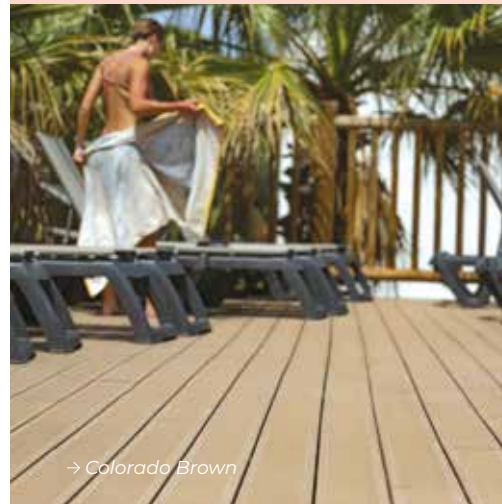

Iroise Grey

Anthracite Grey

Exotic Brown

Colorado Brown



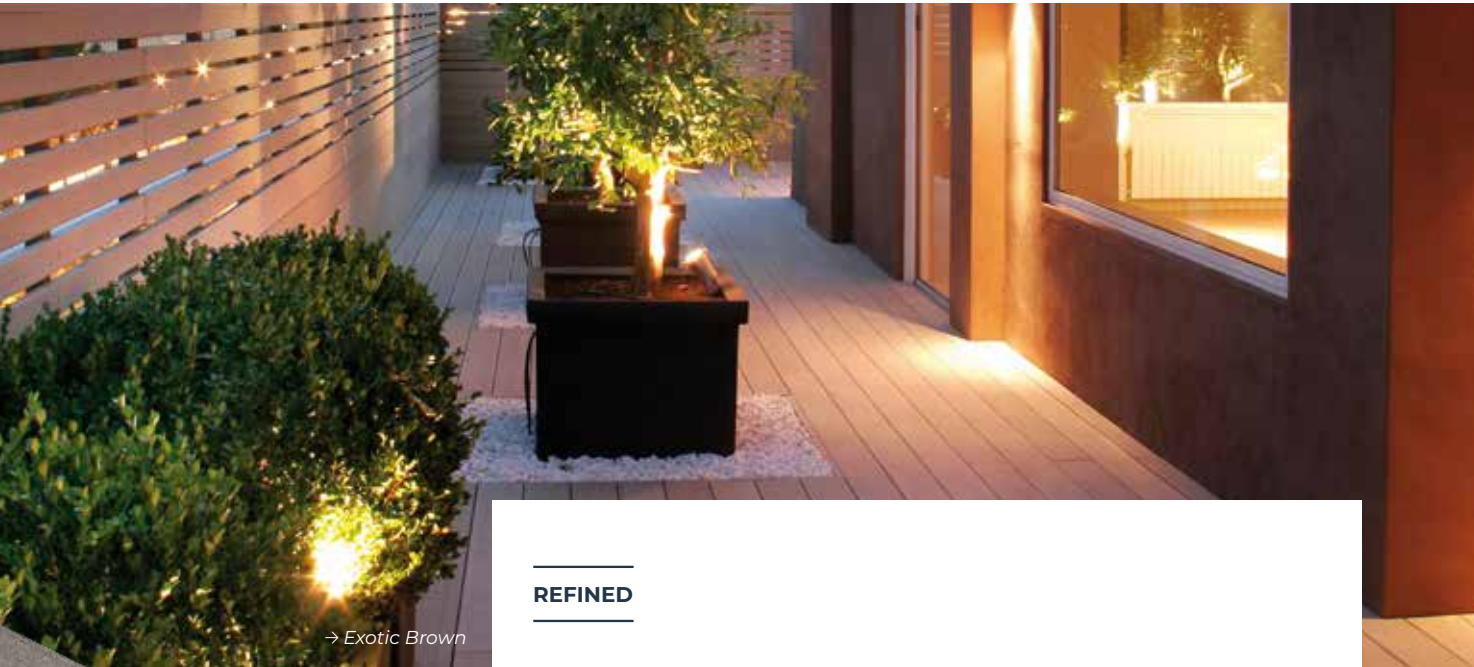

→ Exotic Brown

REFINED

Smooth Elegance board

Are you looking for a contemporary decking with an understated, refined look? Choose the smooth board for a bold, original design that mixes the different finishes in the Elegance range.



Available in 2 widths:
138 and 180 mm



→ Anthracite Grey



→ Anthracite Grey



→ Colorado Brown

AUTHENTIC

Embossed Elegance board



Length 4 m,
width 138 or 180 mm

You will love its surface finish, resembling the veined pattern of wood grain. It softens over time, giving an increasingly natural appearance with the passing seasons.

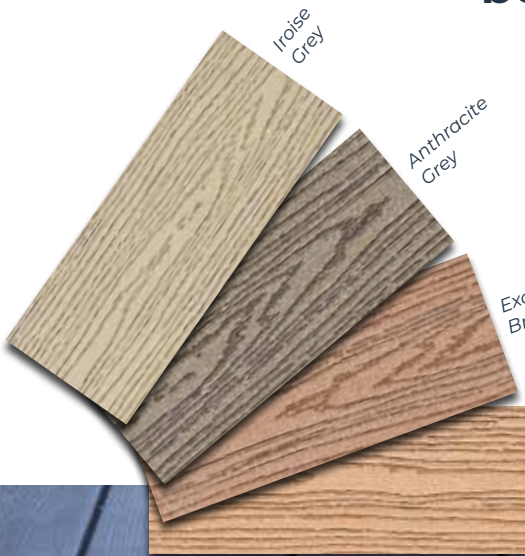

Iroise Grey

Anthracite Grey

Exotic Brown

Colorado Brown



→ Anthracite Grey



→ Anthracite Grey

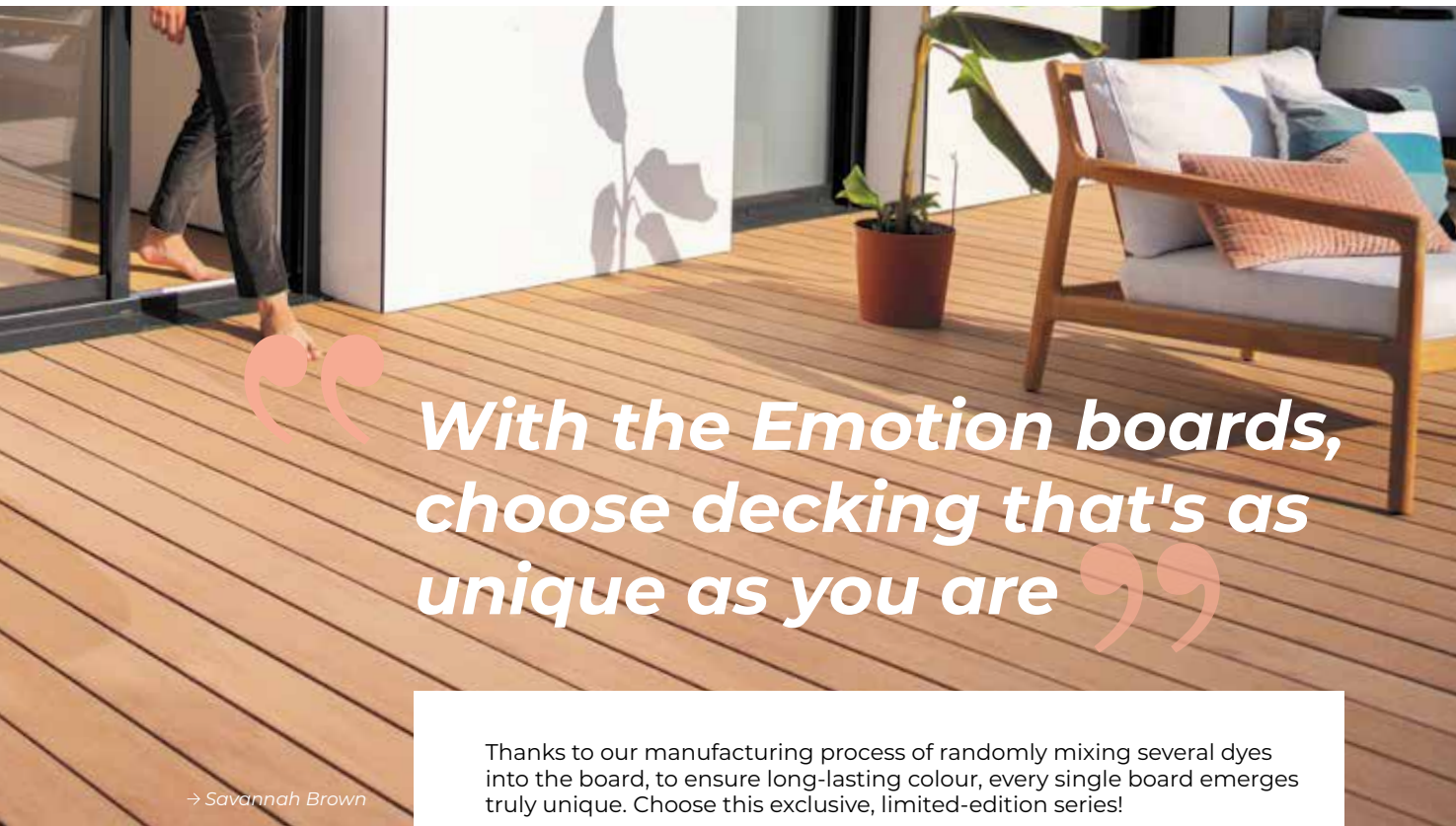

→ Savannah Brown

**With the Emotion boards,
choose decking that's as
unique as you are**

Thanks to our manufacturing process of randomly mixing several dyes into the board, to ensure long-lasting colour, every single board emerges truly unique. Choose this exclusive, limited-edition series!

The + points

Splinter-free

*Does not fade to
grey like solid wood*

*No treatment
is required*

Rot-resistant

UV-resistant

Frost-resistant

Guaranteed for 25 years*

**Terms of the warranty
can be downloaded
from www.silvadec.com*

Smooth
finish

SCRATCH RESISTANCE

*

EASE OF REPAIR OF THE SURFACE
APPEARANCE (SIMPLY BY SANDING)

SLIP RESISTANCE

**

COMFORTABLE BAREFOOT ON SUNLIT
SURFACE (T° OF THE BOARD IN THE SUN)
COMPARED TO EXOTIC WOOD

**

EASY CLEAN-UP OF
HOUSEHOLD STAINS

**

USES

- Decking and swimming pool decks
- Outside (not suitable for covered or semi-covered locations)



A bronzing phenomenon, entirely natural and temporary, will cause the boards to turn yellow when first exposed to UV rays. After a few weeks outdoors exposed to UV and rain, they return to almost their original colour! (see p. 34)

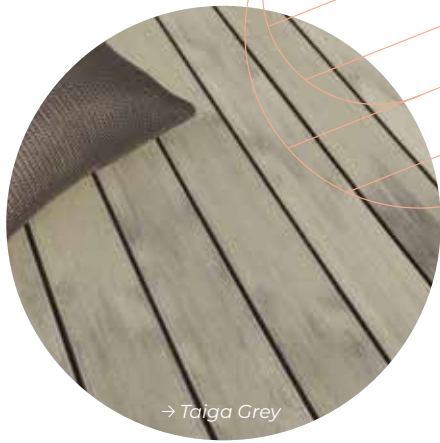

→ Taiga Grey



Savannah Brown

Equator Brown

Taiga Grey



Length 4 m,
width 138 mm



→ Savannah Brown



→ Equator Brown



With the Atmosphere boards, choose peace of mind

Produced through technological innovation, its protective coating renders it waterproof and highly slip-resistant. It will be your best friend when it comes to easy cleaning of household stains.

→ Lima Brown

The + points

- Splinter-free
- Colour stability
- No treatment required
- Rot-resistant
- Frost-resistant
- Guaranteed for 25 years*

* Terms of the warranty can be downloaded from www.silvadec.com

USES

- Residential
- Public facilities
- Decking and swimming pool decks
- Outdoor kitchens, including in sheltered or semi-sheltered areas

Brushed finish

SCRATCH RESISTANCE

**

SLIP RESISTANCE

COMFORTABLE BAREFOOT ON SUNLIT SURFACE (T° OF THE BOARD IN THE SUN) COMPARED TO EXOTIC WOOD

*

EASY CLEAN-UP OF HOUSEHOLD STAINS

BRUSHED APPEARANCE OF THE SURFACE

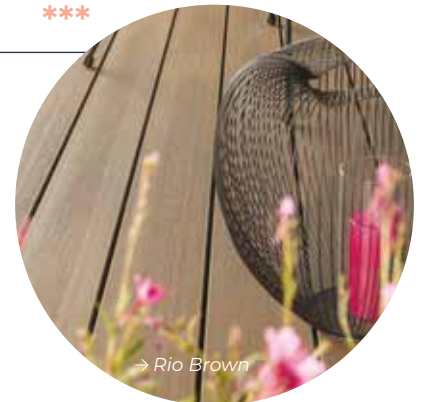

→ Rio Brown

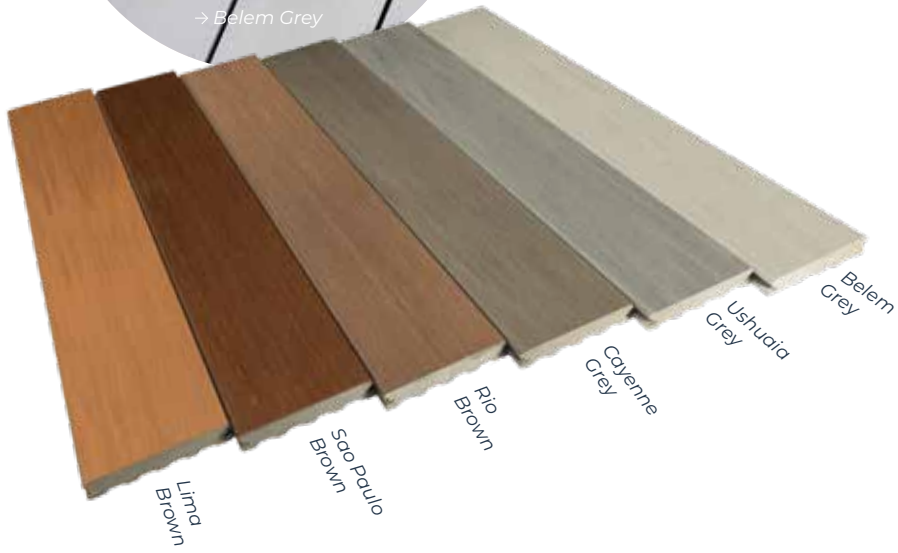

Length 4 m,
width 138 or 180 mm

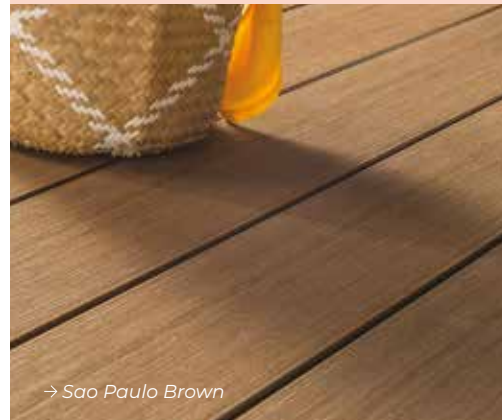

→ Ushuaia Grey

Create your decking

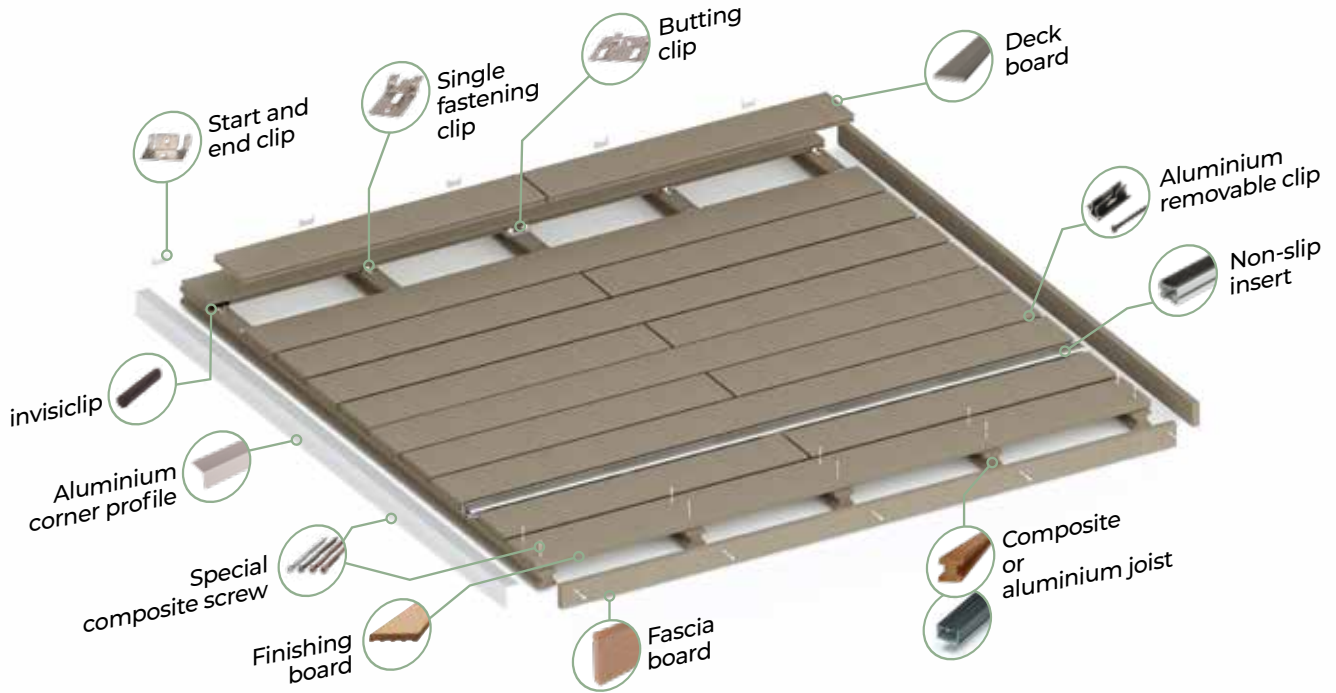

INSTALLATION ACCESSORIES

PEDESTAL MOUNTING

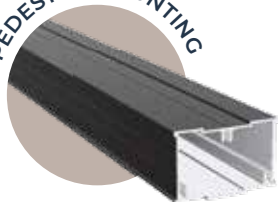

ALUMINIUM JOIST

Enables installation of wide-spaced pedestals: 60 cm for a private installation.
Joist: 63 x 40 x 3600 mm

INSTALLATION ON CONCRETE SLAB



COMPOSITE JOIST

Used only for flat installation on a concrete slab.
Brown: 50 x 50 x 4000 and 50 x 50 x 3000 mm



SINGLE FASTENING CLIP AND STAINLESS STEEL SCREW

For board / joist intersections.



The screws supplied with our clips are not suitable for the aluminium joist



ALUMINIUM REMOVABLE CLIP

This is used to create an access hatch for an element located below the decking, or to make the decking partially removable.
Packet of 10 clips with screws.

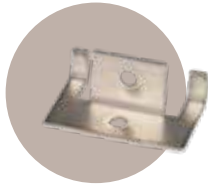

STAINLESS STEEL START AND END CLIP

This is used to fix the boards along the edge of the decking to each joist.

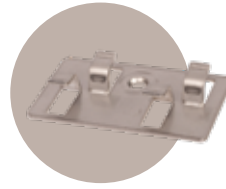

STAINLESS STEEL BUTTING CLIP

This is used to join 4 board corners to a single joist using only one fastening clip. This clip is not compatible with the aluminium joist.



SPECIAL STAINLESS STEEL COMPOSITE SCREWS

Screws to match the colours of our deck board range.

FINISHING ACCESSORIES



FASCIA BOARD

Completes the decking.
70 x 20 x 2000 mm
Available in all Elegance, Emotion and Atmosphere board colours.



FINISHING BOARD

For framing the decking.
138 x 23 x 4000 mm
and 180 x 23 x 4000 mm
Available in the colours of the Elegance and Atmosphere ranges.

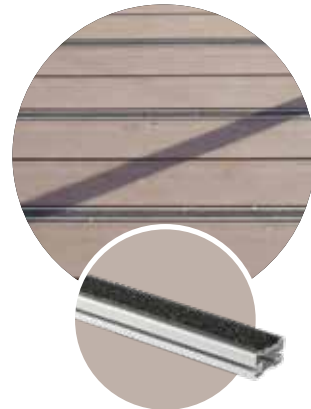

NON-SLIP INSERT (ALUMINIUM AND EPOXY RESIN)

Complies with all non-slip requirements.
Is inserted between two deck boards.
45 x 23 x 2000 mm



ALUMINIUM CORNER PROFILE

Enhances the edge of the decking.
It has a non-slip grooved upper surface.
37 x 74 x 2000 mm



INVISICLIP

Made of black rubber and very discreet, to conceal the clip.
10 x 10 x 80 mm
Packet of 30

LIGHTING ACCESSORY



SOLAR FLOOR LIGHT

Solar ground-level lights that create atmosphere, without requiring an outside power connection; they come on automatically at night.
H 35 mm
Drilling Ø: 35 mm
Waterproof to: IP65
Box of 4 floor lights



Find all our
maintenance advice
and products on pages
34 of the catalogue!



Our fencing

Choose a modular fence that will last

Our Silvadec® fencing can be tailored to all your projects and any type of ground. It combines innovative and strong materials. Choose one of our Atmosphere or Aluminium fencing board models, then personalise your fence from the wide selection of design panels.

Atmosphere board	P. 20
Aluminium board	P. 22
Fencing design panels	P. 25
Create your fence	P. 27
Doors	P. 29

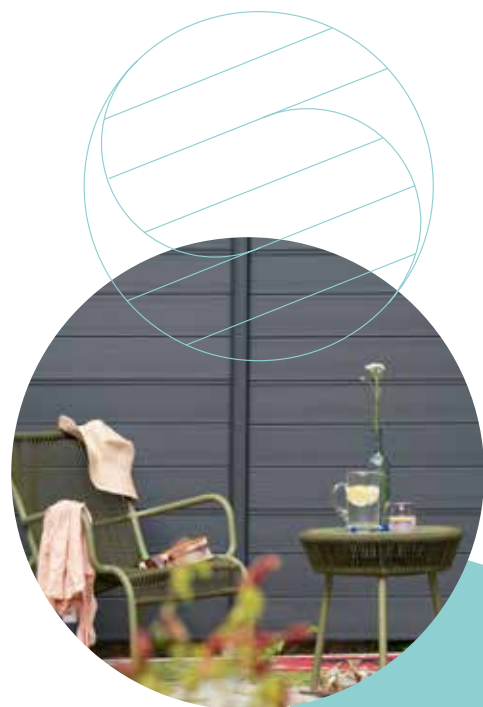



★ NEW!

“With the Atmosphere boards, say yes to technical innovation”

→ Wild Grey

Thanks to its protective envelope of polymer material, our Atmosphere fence board offers exceptional qualities in terms of usage and comfort. It is intensely coloured, warm to the touch, particularly resistant to UV rays and stains, and cleaned with a simple wipe of a sponge!

The + points

- Permanent and uniform colour
- Stain-resistant
- Easy to maintain
- Guaranteed for 25 years*

 Our fences can be installed up to a height of 1.8 m, and can withstand strong winds of up to 100 km/h.



→ Light Grey

USES

Can be installed on a dwarf wall

* Terms of the warranty can be downloaded from www.silvadec.com

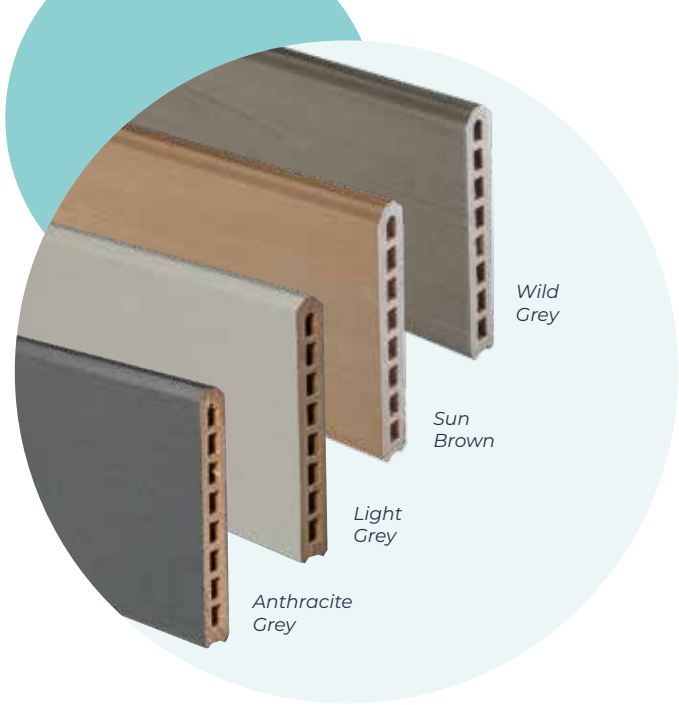

Wild Grey

Sun Brown

Light Grey

Anthracite Grey

Dimensions: 21 x 150 x 1783 mm

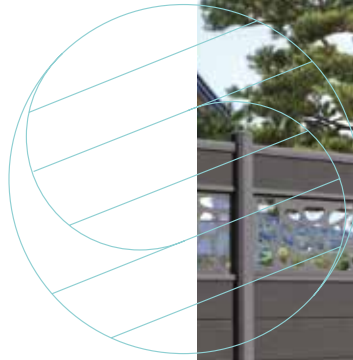

→ Anthracite Grey

★ NEW!



→ Sun Brown

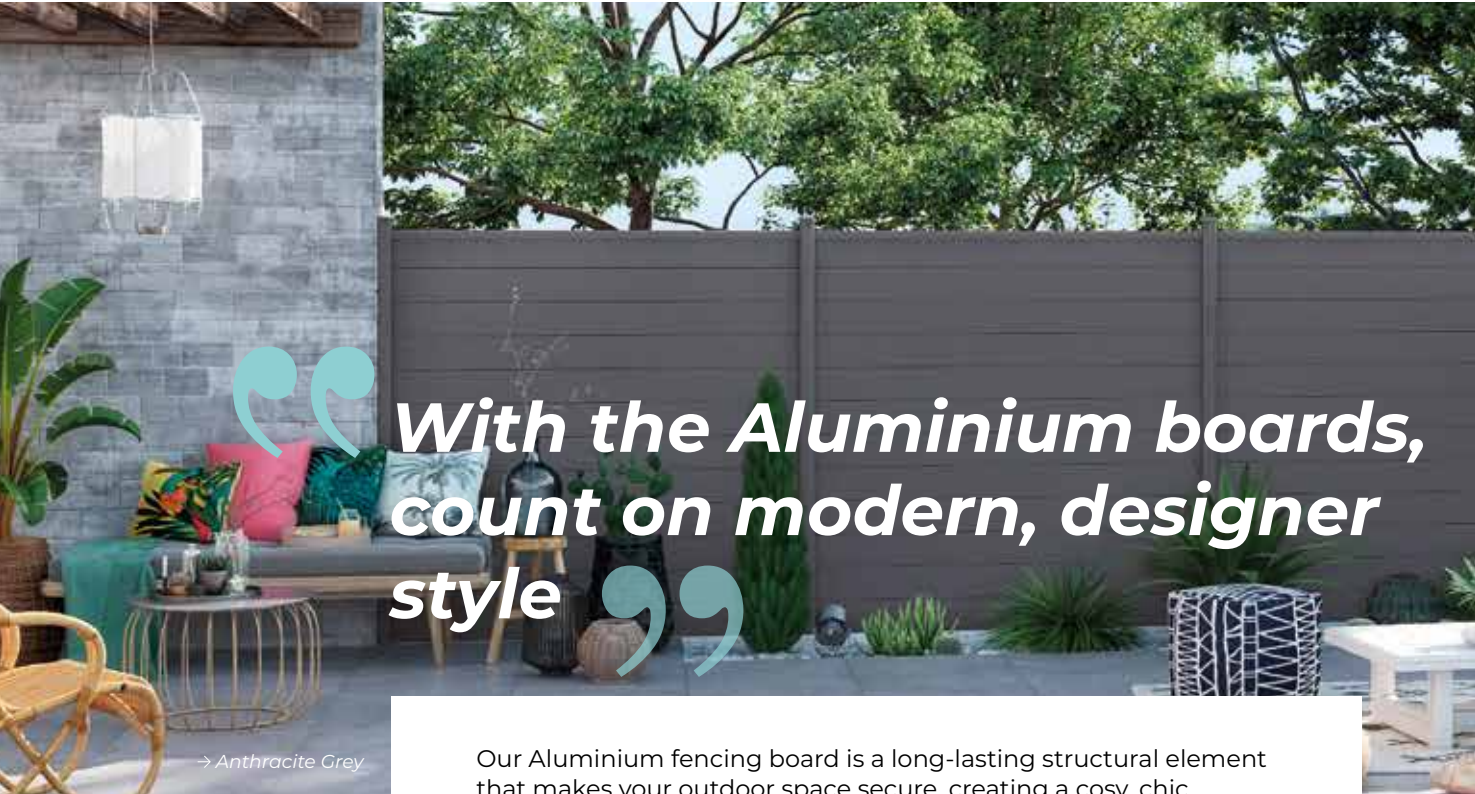

→ Anthracite Grey

**With the Aluminium boards,
count on modern, designer
style**

Our Aluminium fencing board is a long-lasting structural element that makes your outdoor space secure, creating a cosy, chic private area. It is exceptionally easy to maintain, and offers many configuration options so you can give creativity a free hand! Installed either "solid" or openworked using dividers, which are sold separately

The + points

Compatible with all
Silvadec® accessories
and design panels

Installed either "Solid"
or openworked using
dividers, which are
sold separately

Easy maintenance

Recyclable

Guaranteed for 10 years*

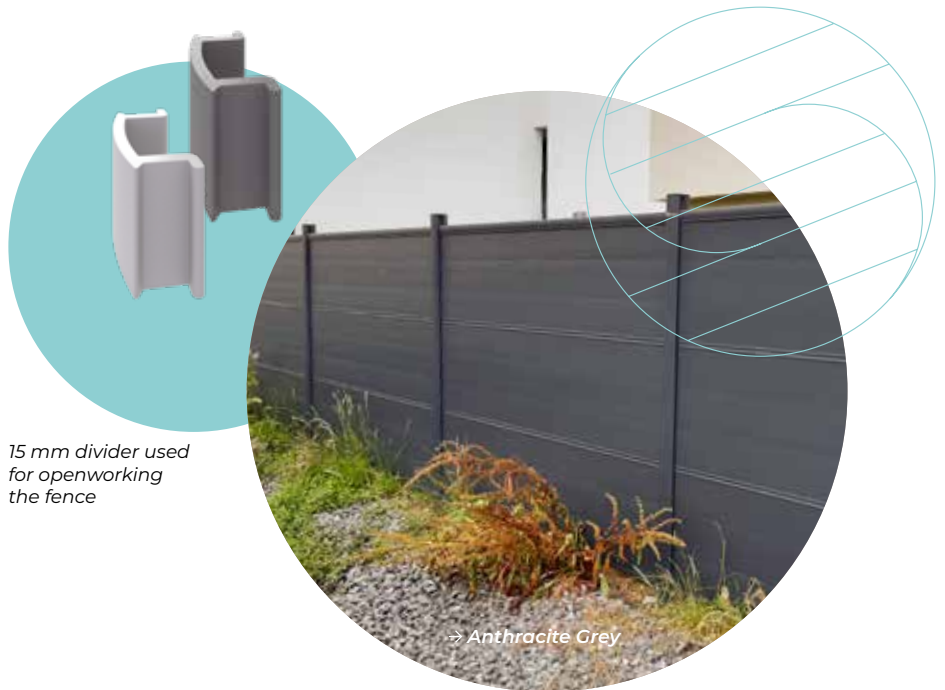

15 mm divider used
for openworking
the fence

→ Anthracite Grey

* Terms of the warranty can be downloaded from www.silvadec.com

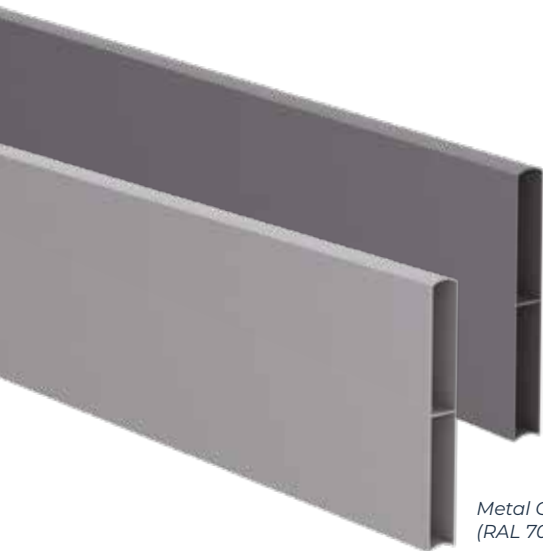

*Anthracite Grey
(RAL 7016 matt)*

*Metal Grey
(RAL 7042 matt)*

Dimensions: 21 x 148 x 1797 mm



→ Metal Grey



→ Metal Grey

Combine composite and aluminium boards in your fencing

Our wide range of accessories and design panels is compatible with both aluminium and composite fence boards.

This offers you the freedom to use composite and/or aluminium panels together, enabling you to create different moods in your garden.





**Choose and customise
your fence pieces** ”



→ Ushuaia Grey

With the Silvadec® design panels, you'll discover made-to-measure solutions to meet your landscaping needs, to customise and modernise your fence. Our aluminium design panels slot easily between two composite fence boards. Bring a touch of originality and welcome to your garden!

PLANT MOTIF AMBIANCE



**Plant
motif design
panel in
aluminium**

Fine, tapered grass styling in this lightly openworked design panel, 30 cm high, brings a touch of freshness to your garden.

**REPLACES
2 FENCE BOARDS**

Modular, pleasant and customisable, our galvanised steel trellis offers multiple possibilities to bring greenery into a fence! This unique decorative panel fits perfectly into the environment of your garden. Next, it's over to you to choose your plants!

**Botanical
panel**



MINERAL AMBIENCE



Mineral motif design panel in aluminium

Our openwork design panel, 30 cm high, allows light to shine through, while its rounded shapes will bring harmony to your outside space.

**REPLACES
2 FENCE BOARDS**

Made of galvanised steel and decidedly modern, our panel fits harmoniously into the fencing. The next step is to fill it with gravel of whichever colour you choose!

The mineral gabion panel



CONTEMPORARY STYLE



Urban motif design panel in aluminium

Combining elegantly with our composite boards, this design panel, 30 cm high, offers a modern and refined style suitable for all outdoor environments.

**REPLACES
2 FENCE BOARDS**

Our glass panels allow light to shine through, bringing a touch of brightness and refinement to your fencing. Available in frosted glass (opaque) and transparent versions, with a height of 43.2 cm.

**REPLACES
3 FENCE BOARDS**

Glass design panel



Create your fence

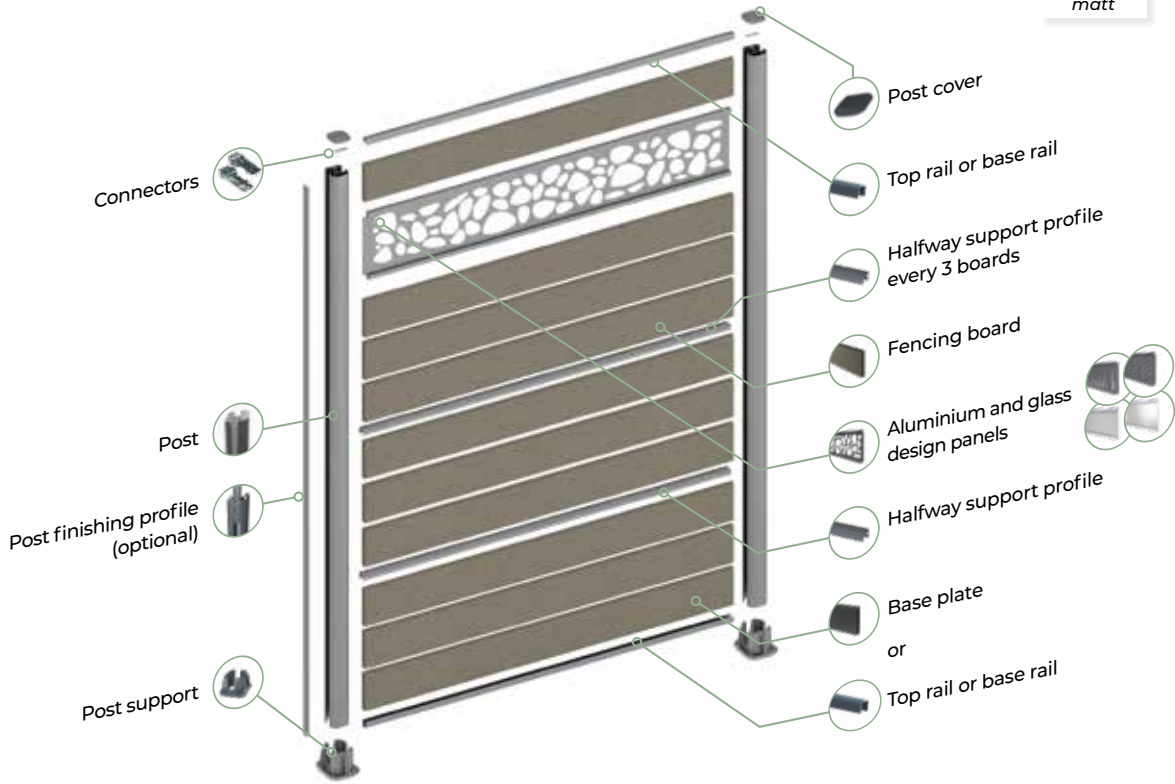
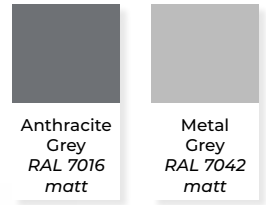

INSTALLATION ACCESSORIES



3-IN-1 HIGH-WIND POST

It is positioned at the start, middle and end of the fence.
70 x 64 x 1260 mm
and 70 x 64 x 2315 mm

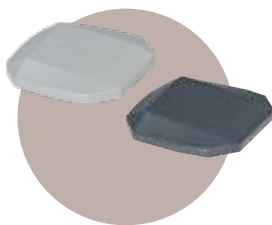

POST COVER

65 x 70 mm



DOUBLE-SHELL POST SUPPORT

Dedicated support for 3-in-1 high-wind post, for improved post hold. For a max. height of 1845 mm.
108 x 133 x 83 mm

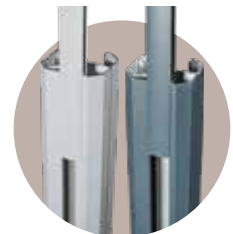

POST FINISHING PROFILE

To give the fence an attractive finish.
27 x 9.5 x 1815 mm

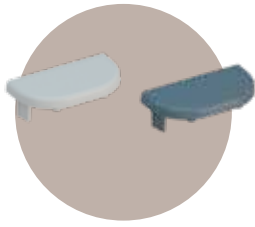

WALL START SEMI-POST COVER

70x35 mm

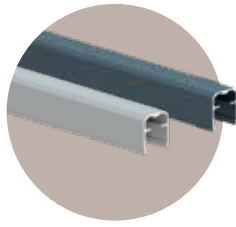

TOP RAIL OR BASE RAIL

Each panel must have two rails mounted horizontally, one at the top and one at the bottom of the fencing.
26 x 30 x 1736 mm

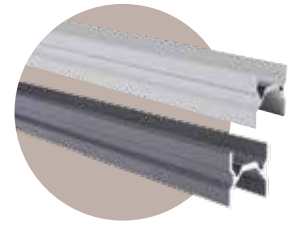

HALFWAY SUPPORT PROFILE

Insert one profile at least every three boards.
23.3 x 24 x 1736 mm

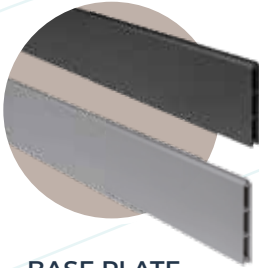

BASE PLATE

Simplifies installation on sloping ground, by immediately creating a flat surface. Prevents the first board from coming into contact with the ground.
21 x 153 x 1798 mm

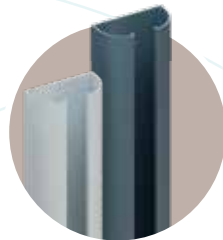

WALL START SEMI-POST

This is used for starting the fence against a wall, guaranteeing an elegant finish.
70 x 35 x 1845 mm

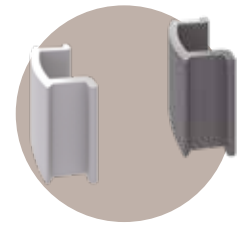

DIVIDERS

For openworking aluminium fence boards; not compatible with the composite boards. Packet of 22 x 15 mm stackable dividers.

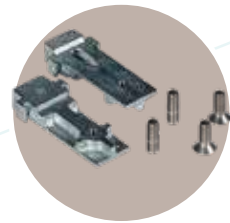

TOP RAIL CONNECTORS

Increases the durability of your fence. It helps ensure vertical positioning of the post and centre-to-centre distances. Simplifies installation.

The door: secure access that blends right in

Our elegant and modern garden door fits between two masonry pillars or within a Silvadec® fence. Compatible with the aluminium sanded-finish range of fences and accessories.



Anthracite Grey

The + points

Compatible with the range of aluminium fences and accessories

Complies with the standard for reduced-mobility access (passage width > 83 cm)

Easy maintenance

USES

- Install directly between two masonry pillars
- Install on posts to make an opening in a fence





Our cladding types

Transform your home with a bold "second skin" effect

Give your home a whole new look with our cladding solutions!
Our Silvadec® sun shade and our open rhombus cladding board will put a personal stamp on your home exterior.

Sun shade.....	P. 31
Open rhombus cladding board	P. 32
Atmosphere 175 cladding	P. 33



“ **With the sun shade,
choose aesthetic appeal
and comfort too** ”

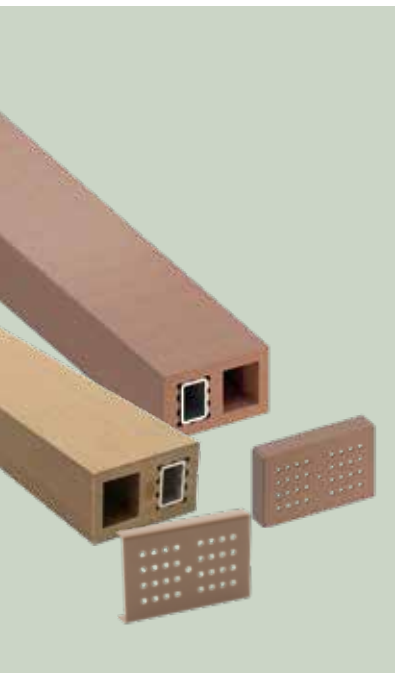

Enhance the comfort of your living space by modifying the brightness and temperature, with our sun shade.

Reduce direct solar radiation into your home, and regulate heat while letting light in. Just what you need to create an aesthetic and functional architectural whole!

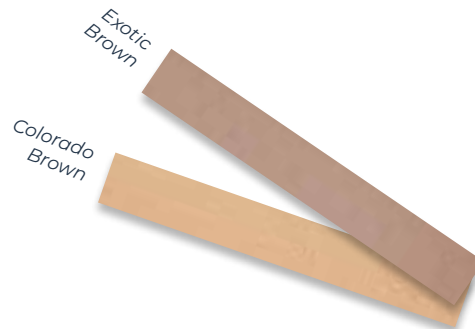

**The +
points**

Doesn't fade to grey

*Resistant to insects
and fungi*

Long-lasting colour

*Guaranteed
for 25 years**

**Terms of the warranty
can be downloaded from
www.silvadec.com*



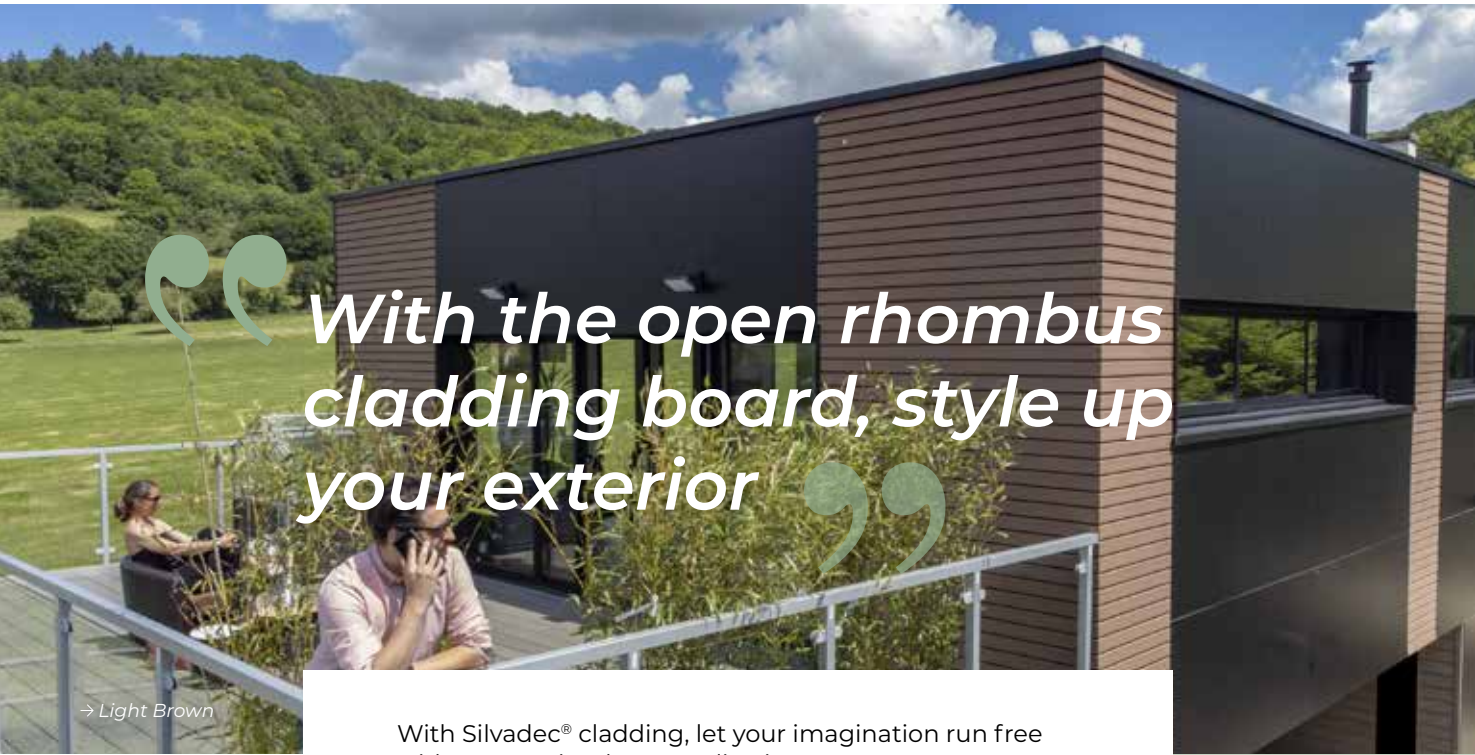

“With the open rhombus cladding board, style up your exterior”

→ Light Brown

With Silvadec® cladding, let your imagination run free with unrestrained personalisation!

The open rhombus cladding board gives buildings a more modern look and offers new solutions for exterior decoration.

As well as looking great, this cladding offers a surprising range of on-trend colours!

The + points

Easy maintenance

No treatment is required

Permanent and uniform colour

Guaranteed for 25 years*

* Terms of the warranty can be downloaded from www.silvadec.com

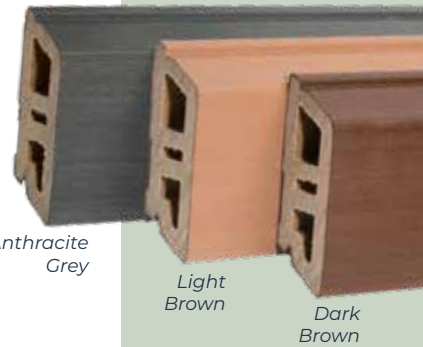

Anthracite Grey

Light Brown

Dark Brown

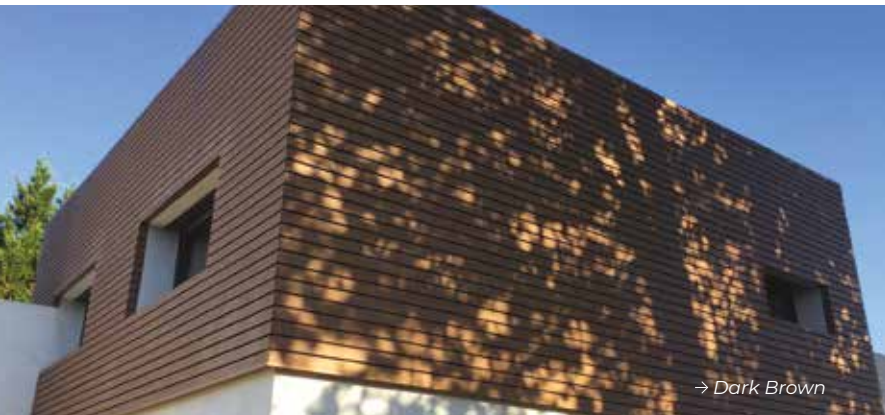

→ Dark Brown



→ Anthracite Grey



→ Limewash White

“ ***My cladding reaches new heights with the Atmosphere 175 board!*** ”

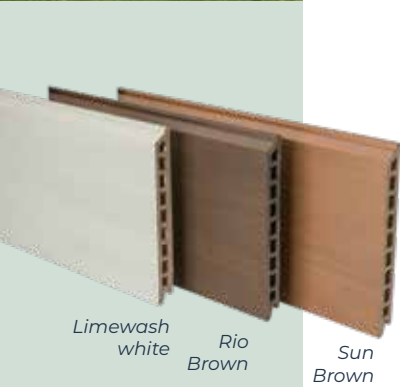

Limewash white

Rio Brown

Sun Brown

You can count on the modern lines of our Atmosphere 175 board to create cladding with character. Thanks to the quality of its constituent materials and our exclusive manufacturing process, your cladding's colour remains totally stable over time, without treatment, saturators or painting!

The + points

On-trend colours

Installation options

No treatment needed

Rapid installation

*Guaranteed for 25 years**

**Terms of the warranty can be downloaded from www.silvadec.com*



→ Sun Brown



Our advice on maintenance



Silvadec® composite boards do not require special protection (no treatment product). Regular cleaning is all that is required to keep the boards in good general condition.

ELEGANCE AND EMOTION BOARDS



It is essential to wash your decking once a year, ideally in spring, using a **broom** and soapy water, which should be warm, for optimum effectiveness.

Composite boards are mostly made of wood and are therefore susceptible to staining, dependent on the product's environment, its use and your regional climate. Stains are always on the surface of the board and never alter the structure of the product. Most stains wash off easily with soapy water and a broom. Household stains (greasy) fade naturally if they are exposed frequently to UV and the weather.



TEMPORARY BRONZING

The Elegance and Emotion boards **yellow temporarily during the first few weeks after installation**. This natural phenomenon disappears after exposure to the sun and to the weather, at which point the boards will revert to almost their original colour!

This bronzing may last longer if the boards are installed in semi-sheltered or sheltered areas. In this case, if water spots persist, it is possible to speed up their disappearance by using a jet of water and a broom to brush along the length of the boards.

Before exposure to UV rays **After a few hours in the sun** **After a few weeks of exposure to the weather**



ORIGINAL COLOUR **NATURAL BRONZING** **STABILISED COLOUR**



ATMOSPHERE AND ALUMINIUM BOARDS

It is essential to wash decking and fencing once a year, ideally in spring, using soapy water, which should be warm for optimum action. We strongly recommend using a **broom** to wash Atmosphere boards and a **sponge** to wash Aluminium fences, as some long-handled brooms can cause scratches.

> ON ALL SILVADEC® PRODUCTS

THINGS YOU SHOULD NEVER DO

- Do not use high-pressure cleaning equipment, which makes the surface slightly porous and so more prone to staining
- Do not use solvent
- Do not apply staining oil, paint or protective/restorative products.



> OUR MAINTENANCE PRODUCTS



GREASY STAINS

SILVAWASH

- Clay-based, 100% mineral origin
- Especially for composite
- To be used dry
- Net weight: 200g

Ref. SINET1501



STUBBORN STAINS

SILVANET

- Especially for composite
- Removes **ground-in stains**
- Capacity: 1 l

Ref. SINET1201



GREEN DEPOSITS AND LICHENS

SILVATION

- Ready for use, without rinsing
- Capacity: 5 l (20/25 m²)
- Ideal for heavy one-off "scrubbing" actions

Ref. SINET1801



For more information, consult the maintenance sheets available at www.silvadec.com

Simple
and practical!
Create your
project
online.



www.silvadec.com

Distributor:

Reach us at:



silvadec

Life is composite



Silvadec France

21 Parc d'Activités de l'Estuaire · F - 56190 Arzal
Tel. +33 (0)2 97 45 09 00 · e-mail: info@silvadec.com

Silvadec Germany

Ludwig-Erhard-Straße 3 · D - 84069 Schierling
Tel.: +49 9451 9443 500 · e-mail: info-germany@silvadec.com